

# U N I K A

Future classics



# Contents

Desks

Acoustic screens

Drawer units

Desk cabinets

Cabinets



# MATERIAL PALETTE

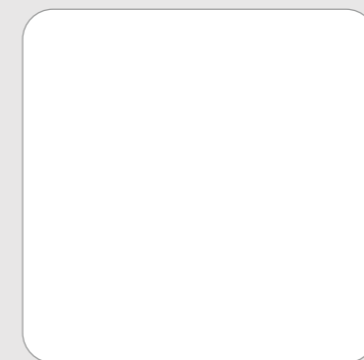
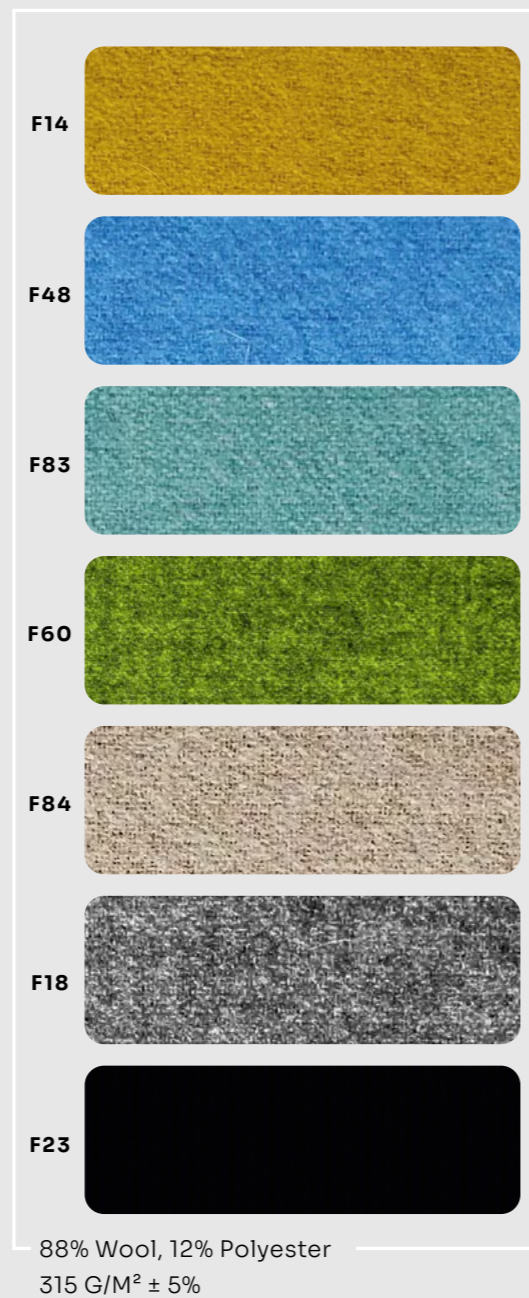
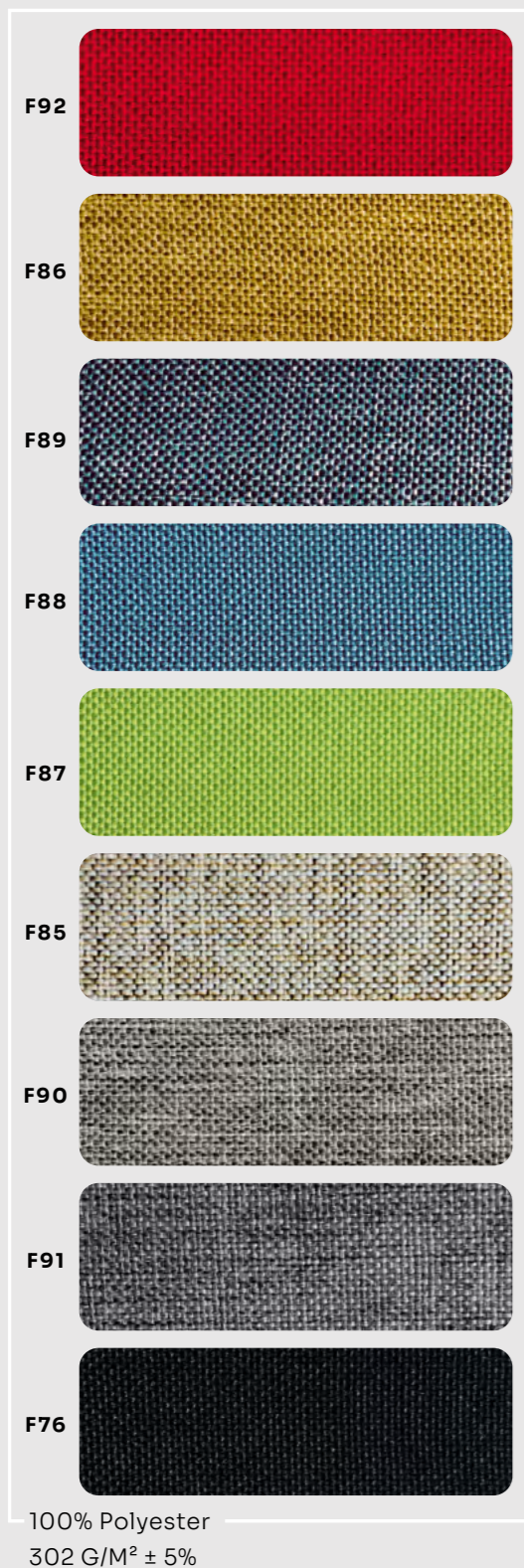

LM7 | White

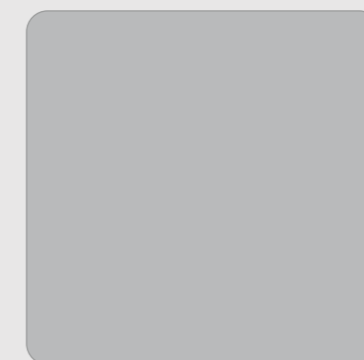

L06 | Grey

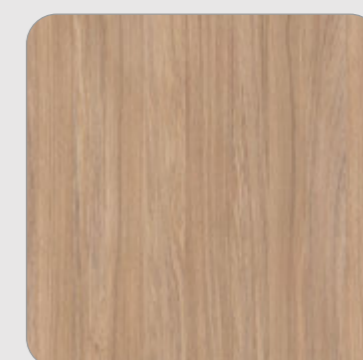

L35 | Amber Oak

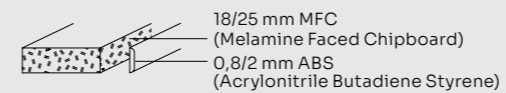

## Panels



M20 | White



M09 | Metallic

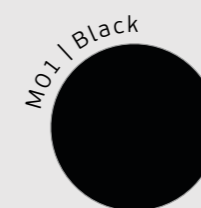

M01 | Black

## Metal

## Fabrics

U N I K A

# DESKS



# A & U DESKS

UNIKA series' desks are designed in light but solid forms, with attention to details and functionality. It is the key for creative work at traditional and modern office, home, public and educational workspaces.

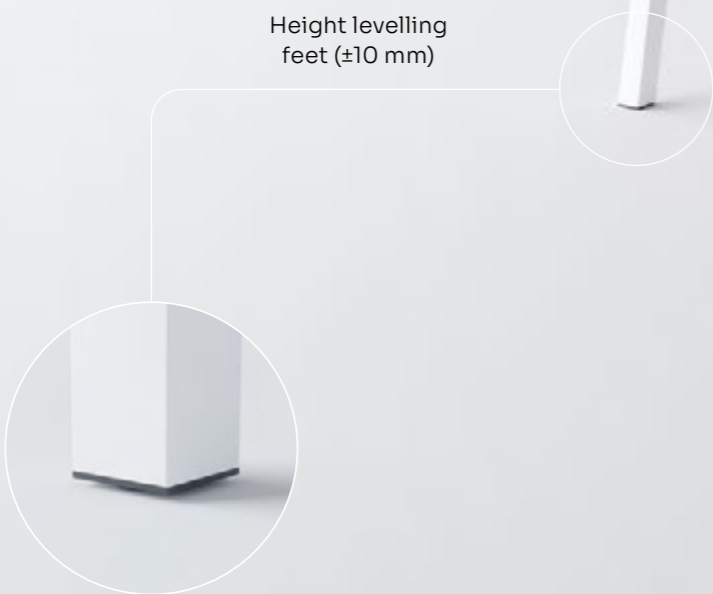

Ergonomic and stable frame under desktop



40x40x2 mm, metal tube, powder coated

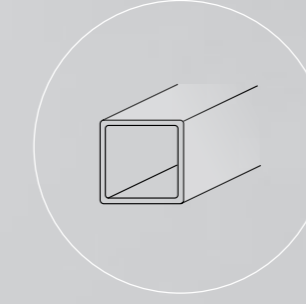

13 mm gap between legs and desktop

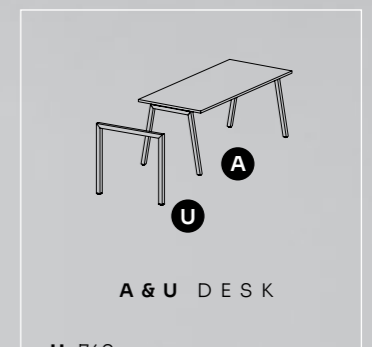

H 740  
L 700/800  
W 1200/1400/1600/1800

# SIT-STAND DESKS

## In detail

Sit-stand desk – modify your seated working position to introduce more movement and health benefits without interrupting your workflow. Transform your table to the most comfortable work position with a single button touch.

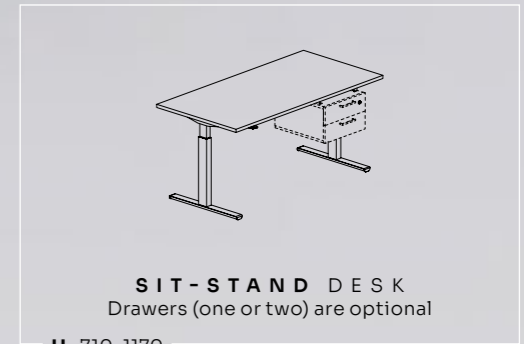
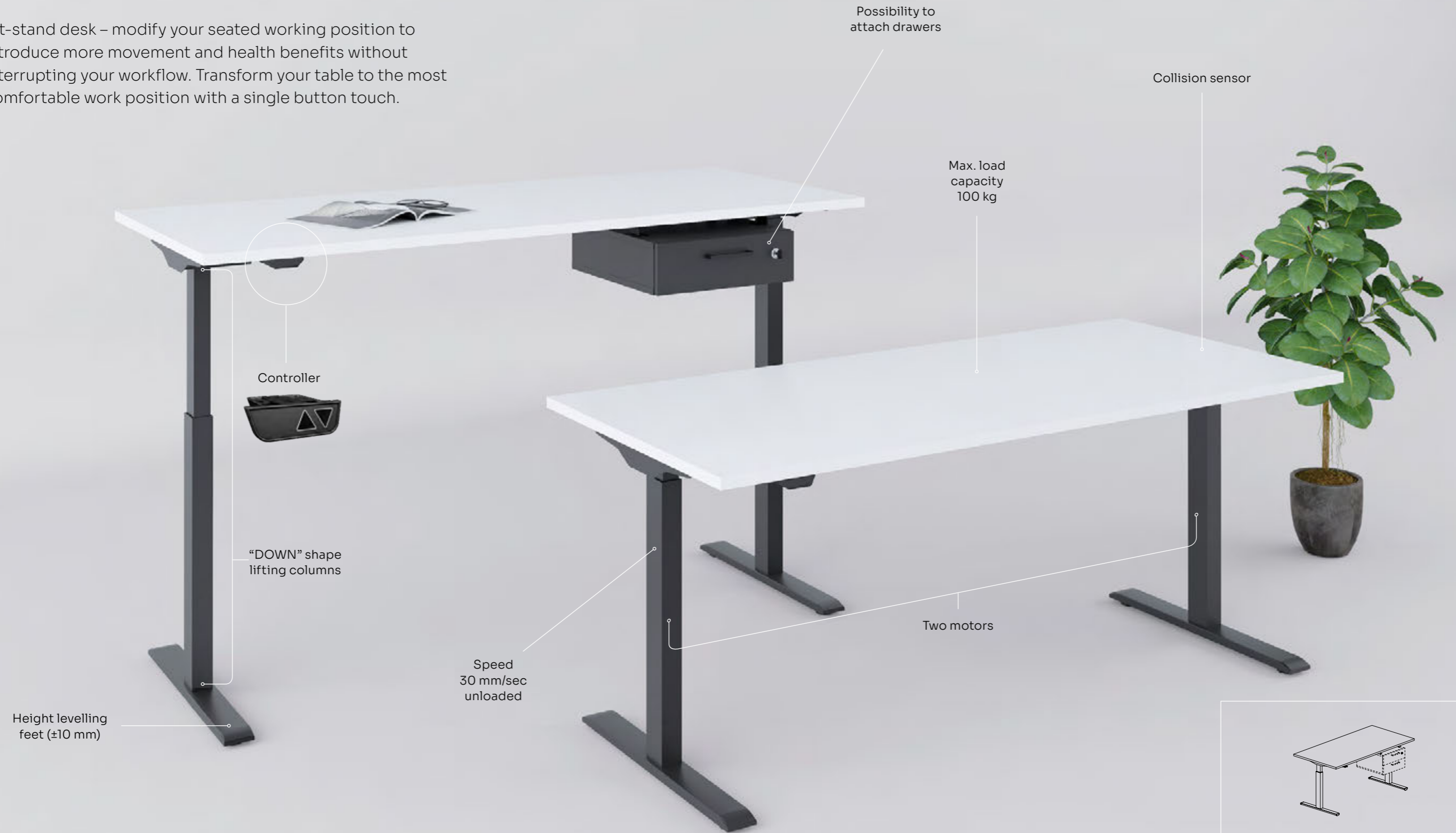

**SIT-STAND DESK**  
Drawers (one or two) are optional

- H** 710-1170
- L** 700/800
- W** 1200/1400/1600/1800

# BENCH DESKS

## In detail

Stylish, yet practical desks to connect and organize an open workspace. Screens, cable management and storage solutions can be used for maximum functionality.

Desk screens optional

Overhang 20 mm

Height levelling feet ( $\pm 10$  mm)

13 mm gap between legs and desktop



**BENCH DESK**  
for two persons; with desk partitions

**H** 740  
**L** 1460/1660  
**W** 1200/1400/1600/1800

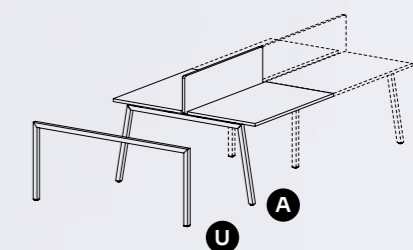

**BENCH DESK**  
for 4-6-8... persons; with desk partitions

**H** 740  
**L** 1460/1660  
**W** 1200/1400/1600/1800

# CONFERENCE DESKS

For meetings and coffee breaks

Unified style continues through the entire UNIKA series.  
The perfect solution for comfortable meetings and coffee breaks.



Cable cover  
320x120 mm

All tables include  
a reinforcement bar  
(50x20 mm)

Height levelling  
feet ( $\pm 10$  mm)



**LOUNGE TABLES**  
for quick gatherings

H 740  
Ø 1070



**COFFEE TABLE**  
for quick gatherings or coffee breaks

H 495  
Ø 600



**CONFERENCE DESK**  
for 4-6 persons

H 740  
L 1000  
W 1600



**CONFERENCE DESK**  
for 6-8 persons

H 740  
L 1280  
W 2400

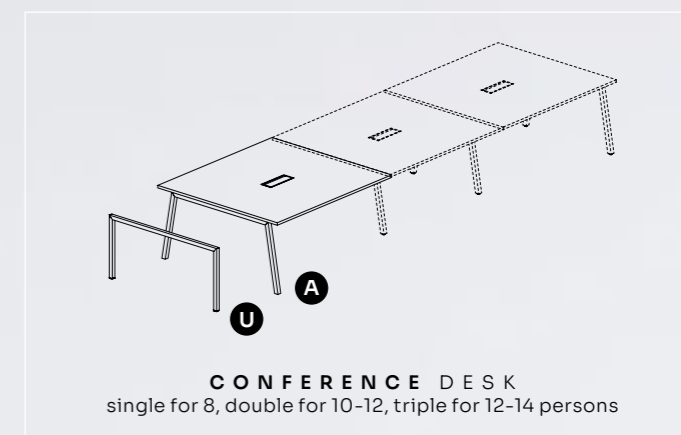

**CONFERENCE DESK**  
single for 8, double for 10-12, triple for 12-14 persons

H 740  
L 1460  
W 1600/3200/4800



# CABLE MANAGEMENT

## solutions & extras

Keep your office look clean and neat with well-organized cable management solutions. Cable covers, guides, trays and PC holders can be applied for all UNIKA series' A & U, Sit-Stand desks.

### Cable covers

For A&U and Sit-Stand desks



80 × 80 square, aluminium

- White
- Metallic
- Black

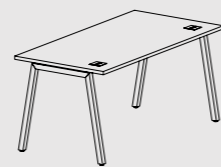

In both desktop sides (2 pc.)



No cable holes

### Extras



**Cable guide**

- Black

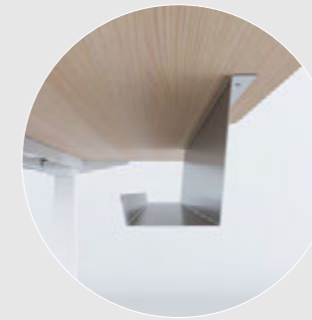

**Cable tray**

120 × 700/900/1100/1300 × 120 mm  
with holes for cable fixing

- White
- Metallic
- Black



**PC holder**

496 × 250 × 200 mm

- White
- Metallic
- Black

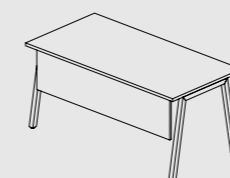

**Modesty panel**

for A&U and Sit-Stand desks.

345 × 1054/1254/1454/1654 × 18



U N I K A

# ACOUSTICS



## B CLASS SOUND ABSORPTION

Sound absorption for UNIKA acoustic screens has been tested in a reverberation room and verified by an accredited laboratory. Measurements were performed according to ISO 354 and ISO 11654 standards in one-third octave bands from 100 to 5000 Hz. The results confirmed acoustic qualities for UNIKA screens with **excellent absorption** at middle and higher frequencies.

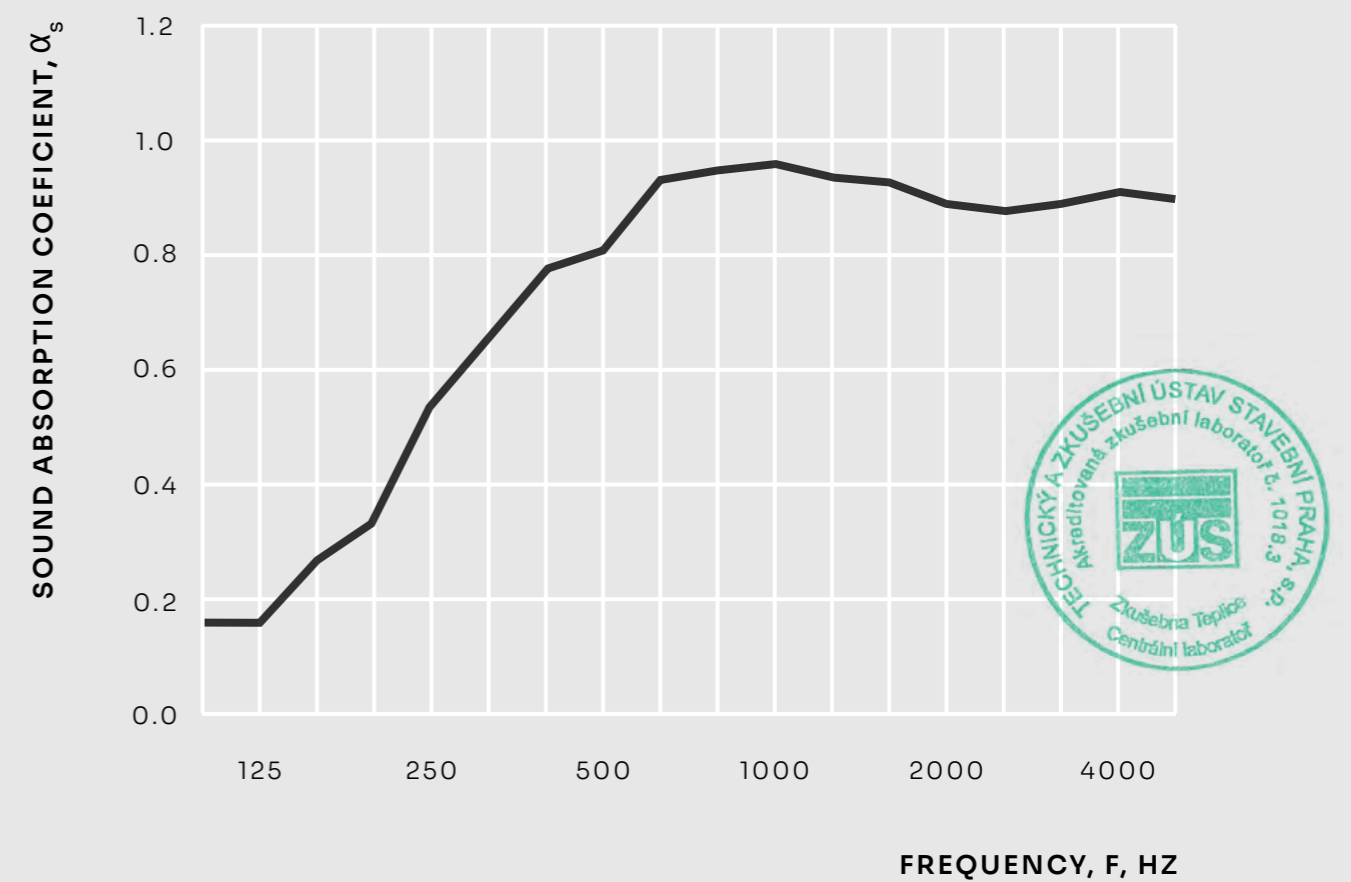

# TABLE SCREENS

Acoustic comfort, privacy and well-designed spaces are targets that can be achieved for traditional workplaces with creative UNIKA acoustic furniture solutions. Acoustic screens create an innovative, stylish and comfortable oasis. Acoustic solutions are compatible with the entire set of UNIKA furniture to increase their functionality.



Acoustic panels contain a certified filling layer STANDARD 100 by OEKO-TEX®

Acoustic class **B**



Zipper on bottom

## Composition options

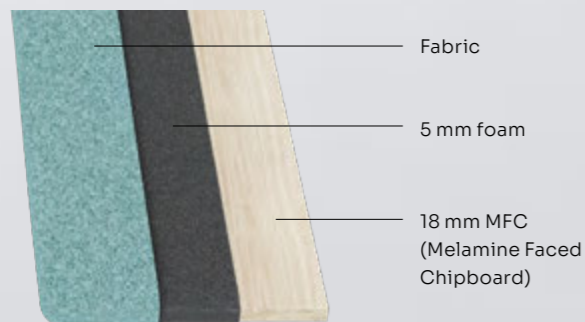

## Fittings

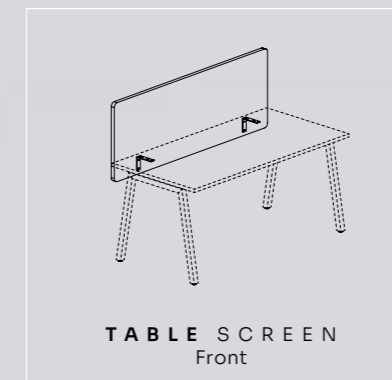
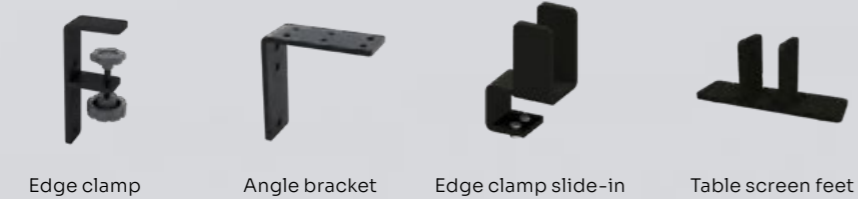

H 650/800  
W 1200/1400/1600/1800/2000  
T 40/30

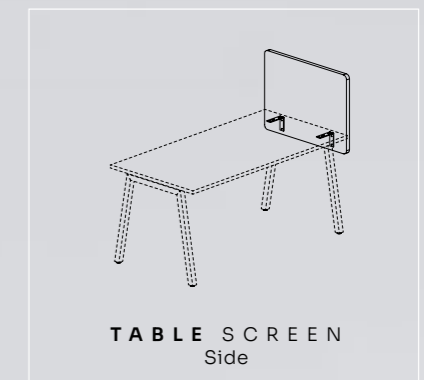

H 450/650/800  
W 700/800  
T 40/30

# FLOOR SCREENS

UNIKA acoustic floor screens are designed to divide open plan office spaces. By reducing noise they provide comfort and well-being in the workplace as well as ensure productive environment. Movable screens can be easily relocated on demand. Colors add visual appeal and coziness to the interior landscape.



Acoustic panels contain a certified filling layer STANDARD 100 by OEKO-TEX®

Acoustic class **B**



Zipper on bottom

## Composition



## Fittings

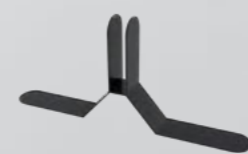

Floor screen feet



Floor screen feet with wheels

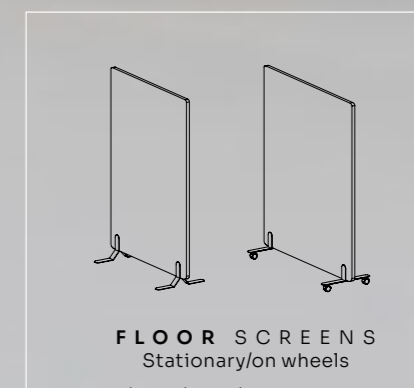

**FLOOR SCREENS**  
Stationary/on wheels

**H** 1200/1400/1600/1800  
**W** 800/1000/1200/1400/1600  
**T** 40

**H** height **W** width **T** thickness

U N I K A

# CABINETS



# DRAWER UNITS

Various size mobile and hanging drawer units to fit all UNIKA series' desks.

## HANDLE OPTIONS

Powder coated handles & brackets

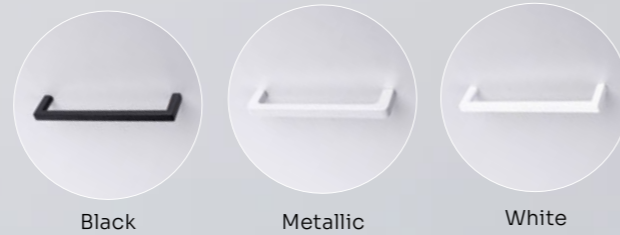

Black

Metallic

White



**!** **HEIGHT**  
Heights are given including brackets and wheels.

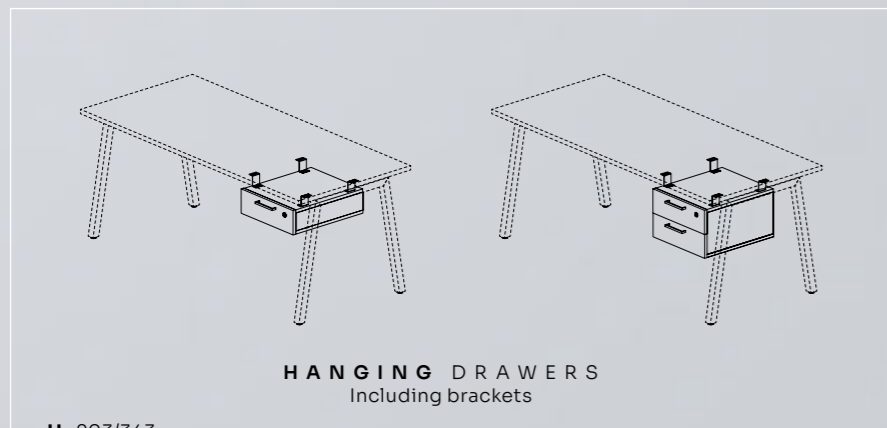

**HANGING DRAWERS**  
Including brackets

**H** 203/343  
**W** 430  
**D** 500



**MOBILE DRAWER UNITS**  
Four drawers

**H** 630  
**W** 430  
**D** 500



**MOBILE DRAWER UNITS**  
Three drawers

**H** 630  
**W** 430  
**D** 500

# DESK CABINETS

Bring functionality, ergonomics and a continuous style of workspace. Cabinets help to organize files, folders, documents and other items in a neat and tidy manner.

## HANDLE OPTIONS

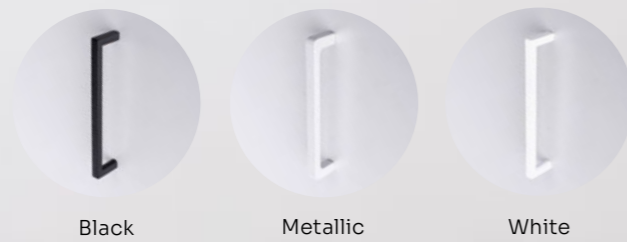

Black

Metallic

White



CABINET WITH LOCK

H 740  
W 700/800  
D 442

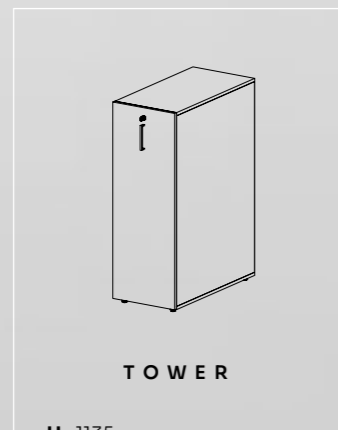

TOWER

H 1135  
W 442  
D 800

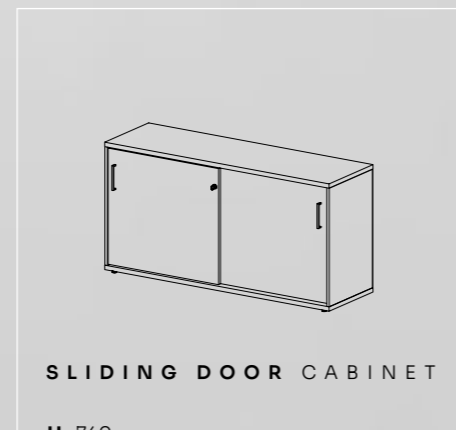

SLIDING DOOR CABINET

H 740  
W 1460/1660  
D 442

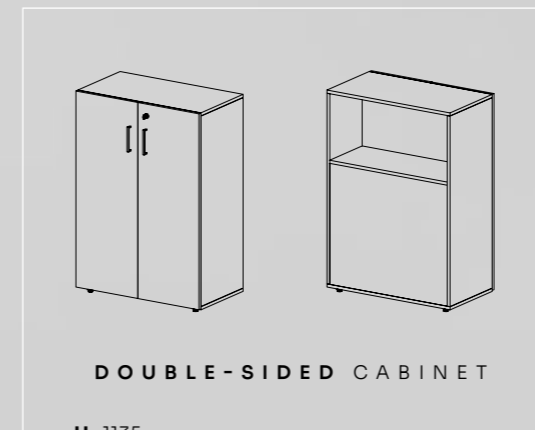

DOUBLE-SIDED CABINET

H 1135  
W 700/800  
D 442

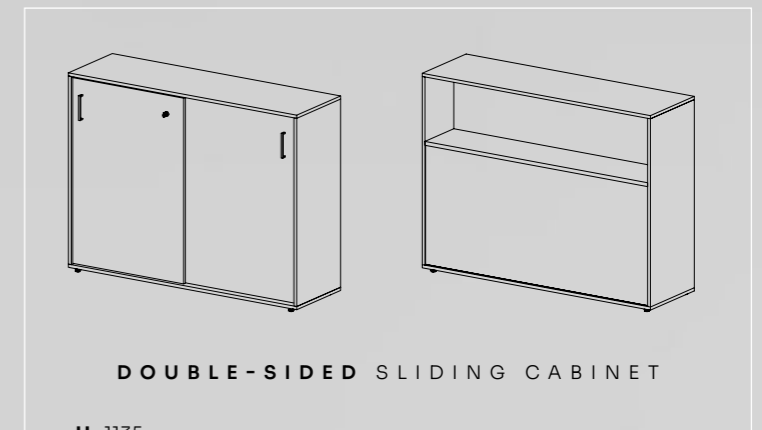

DOUBLE-SIDED SLIDING CABINET

H 1135  
W 1460/1660  
D 442



Lockable

Height levelling feet (±10 mm)

Double-sided design

FRONT VIEW

BACK VIEW



# DOUBLE-SIDED CABINET

In a composition with a Bench desk

This module can be multiplied continuously in the room. Each can be adjusted according to individual needs by attaching an extra drawer, PC holder, cable management elements or other products from UNIKA series'.



Desktop and inner shelf are at the same height



Double-sided design

Cable cover



This height is adjustable  
 $\pm 32$  mm

# CABINETS

UNIKA office cabinets - practical solutions for storing office documents and personal belongings of employees.  
Solutions for your office, educational and medical institutions.

## HANDLE OPTIONS



**!** **BASE**  
All cabinets must be ordered either with socle or furniture feet.

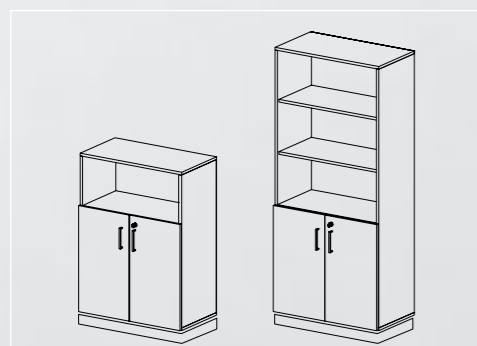

**3 H, 5 H CABINETS**  
partly closed

**H** 1147/1851 with socle | 1091/1795 with furniture feet  
**W** 800  
**D** 442

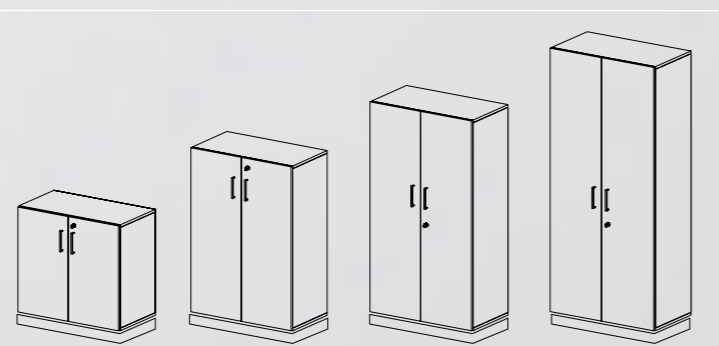

**2 H, 3 H, 4 H, 5 H CABINETS**  
fully closed

**H** 795/1147/1499/1851 with socle | 739/1091/1443/1795 with furniture feet  
**W** 800  
**D** 442

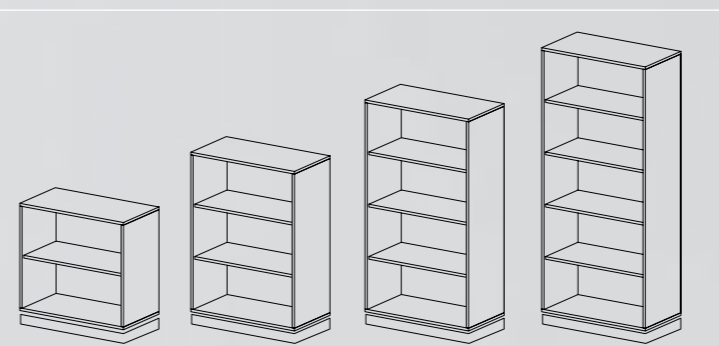

**2 H, 3 H, 4 H, 5 H SHELVES**  
fully opened

**H** 795/1147/1499/1851 with socle | 739/1091/1443/1795 with furniture feet  
**W** 800  
**D** 422

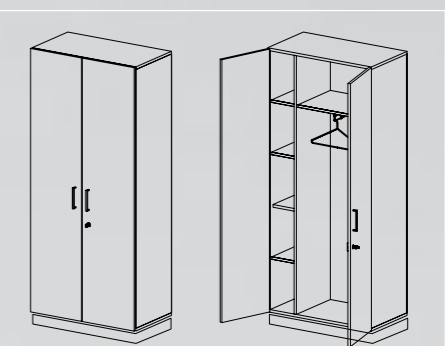

**WARDROBE**

**H** 1851 with socle | 1795 with furniture feet  
**W** 800  
**D** 442

 VILDIKA

[www.kedziucentras.lt](http://www.kedziucentras.lt)  
[info@kedziucentras.lt](mailto:info@kedziucentras.lt)

